

XENPAK 10GB LR

10Gbit/s XENPAK 1310 nm 10GBASE-LR Transponder

Features

- ◆ Compatible with XENPAK MSA Rev.3.0
- ◆ Support of IEEE802.3ae 10GBASE-LR
- ◆ Transmission Distance up to 10km(SMF)
- ◆ Uncooled directly modulated 1310nm DFB Laser
- ◆ Temperature Range 0 to 70°C
- ◆ Adaptable Power Supply (APS:+1.2V)
- ◆ SC duplex Optical connector
- ◆ Hot pluggable 70-pin connector with XAUI electrical interface
- ◆ Management and control via MDIO 2-wire interface
- ◆ Compatible with RoHS

Applications

- ◆ 10GBASE-LR 10G Ethernet

Product Description

The XENPAK 10GB LR is a highly integrated, Serial optical transponder module for high-speed, 10Gbit/s data transmission applications. 4x3.125Gbps Ethernet Signal Input by XAUI Interface. An integrated Coder / Decoder and multiplexer / demultiplexer (SERDES: Serializer / Deserializer). Designing for 10GBASE-LR Transmission with an uncooled directly modulated 1310nm DFB Laser. The transponder operates within a wide case temperature range of 0°C to +70° C and offers optimum heat dissipation and excellent electromagnetic shielding which enables high port densities for 10 GbE systems. A 70 pin electrical connector and a duplex SC connector optical interface assure that connectivity is compliant to the XENPAK MSA Rev.3.0.

Absolute Maximum Ratings

Parameter	Symbol	Min	Max	Unit	Ref.
Storage Ambient Temperature Range		-40	+85	°C	
Powered case Temperature Range		0	+70	°C	
Supply Voltage APS	Vaps	0	1.5	V	
Supply Voltage Range @ 3.3V	Vcc3	-0.5	4.0	V	

Any stress beyond the maximum ratings can result in permanent damage. The device specifications are guaranteed only under the recommended operating conditions.

Recommended Operating Conditions

Parameter	Symbol	Min	Typical	Max	Unit
Operating Case Temperature	Tc	0		+70	°C
Power Supply Voltage	Vcc3	3.13	3.3	3.47	V
	Vaps	1.152	1.2	1.248	
Power Dissipation	PD		3.5	4	W

Electrical DC Characteridtics

(VCC3=3.14V to 3.47V,VCCaps=1.152V to 1.248V,Tc=0 to 70)						
Parameter	Symbol	min.	typ.	max.	Unit	
1.2V CMOS(1.8V CMOS Compatible1)/I/O DC Characteristics (PRTAD;LASI;RESET;TX_ONOFF)						
Output High Voltage	Voh	1				V
Output Low Voltage	Vol			0.15		V
Input High Voltage	Vih	0.84		1.5		V
Input Low Voltage	Vil			0.36		V
Input Pull-down Current	Ipd	20		120		uA
XAUI I/O DC Characteristics (TXLANE[0..3]; RXLANE[0..3])						
Differential Input Amplitude (pk-pk) 4)		220		1600		mV
Differential Output Amplitude (pk-pk) 4)		800		1600		
MDIO I/O DC Characteristics (MDIO; MDC)						
Output Low Voltage	VOL	-0.3		0.2		V
Output Low Current	IOL			20		mA
Input High Voltage	VIH	0.84		1.5		V
Input Low Voltage	VIL	-0.3		0.36		V

- 1) For 1.8 V CMOS Voh = 1.65 V min., Vol = 0.15 V max., Vih = 1.17 V min., Vil = 0.63 V max.
- 2) Rpull-up = 10 kΩ to 1.8 V.
- 3) Vin = 1.8 V.
- 4) AC coupled

Electrical AC Characteridtics

(VCC3 = 3.14 V to 3.47 V, VCC aps = 1.152 V to 1.248 V, TC = 0°C to 70°C)					
Parameter	Symbol	min.	typ.	max.	Unit
XAUI Input AC Characteristics (TXLANE[0..3])					
XAUI Baud Rate	DRin		3.125		Gbit/s
Differential Input Impedance	ZIN	80	100	120	Ω
XAUI Output AC Characteristics (RXLANE[0..3])					
XAUI Baud Rate	DRout		3.125		Gbit/s
XAUI Eye Mask (far-end)	According to IEEE 802.3ae				
Output Differential Impedance	ZO	80	100	120	Ω
Total Jitter ⁴⁾	TJXAUI			0.35	UI
Deterministic Jitter ⁴⁾	DJXAUI			0.37	UI
Power-On Reset AC Characteristics					
Power-On Reset AC Characteristics	According to XENPAK MSA Issue 3.0, 2002-9-18				
MDIO I/O AC Characteristics (MDIO; MDC)					
MDIO Data Hold Time	t _{HOLD}	10			ns
MDIO Data Setup Time	t _{SU}	10			ns
Delay from MDC Rising Edge to MDIO Data Change	t _{DELAY}			300	ns
MDC Clock Rate	f _{MAX}			2.5	MHz

- 1) 100 MHz to 2.5 GHz
- 2) At crossing point
- 3) Per IEEE Std 802.3ae
- 4) At near-end, No pre-equalization, 1 UI = 320 ps.

Optical Interface Operating Conditions

Parameter	Fiber Type	Symbol	Min	Typ	Max.	Units
Operating range	Single Mode Fiber	Lop	2		10,000	m
Data Rate	10GBASE-LRmodule	DR0		10.3125		Gbps

Optical Characteristics

(VCC3 = 3.14 V to 3.47 V, VCC aps = 1.152 V to 1.248 V, TC = 0°C to 70°C, BER1E-12, Bit Rate 10.3125)					
Parameter	Symbol	min.	typ.	max.	Unit
Transmitter					
Average Launch Power	PAvg	-8.2		-0.5	dBm
Transmitter and Dispersion Penalty	TDP			3.2	dB
Center Wavelength Range1)	λ	1260	1310	1355	nm
SMSR	SWSR	30			dB
Extinction Ratio	ER	3.5	6		dB
Relative Intensity Noise ² OMA	RIN			-128	dB/Hz
Eye Mask Definition	According to IEEE 802.3ae				
Optical Return Loss Tolerance	ORLT			12	dB
Average Launch Power of OFF Transmitter	Poff			-30	dBm
Receiver					
Stressed Receiver Sensitivity in OMA	Pssen			-10.3	dBm
Receiver Sensitivity in OMA ²)	Psen			-12.6	dBm
Power Overload	Po	0.5			dBm
Signal Detect Assert Level	PSD			-13	dBm
Signal Detect Hysteresis	PSD	1			dB
Center Wavelength Range	λ	1260		1355	nm

- 1) Conforms to IEEE triple trade-off between center wavelength, RMS spectral width and minimum OMA.
- 2) Receiver sensitivity, which is defined for an ideal input signal is informative only.

Electrical PAD Layout

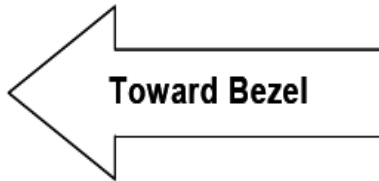







































































70	GND
69	GND
68	RESERVED
67	RESERVED
66	GND
65	TXLANE3-
64	TXLANE3+
63	GND
62	TXLANE2-
61	TXLANE2+
60	GND
59	TXLANE1-
58	TXLANE1+
57	GND
56	TXLANE0-
55	TXLANE0+
54	GND
53	GND
52	GND
51	RXLANE3-
50	RXLANE3+
49	GND
48	RXLANE2-
47	RXLANE2+
46	GND
45	RXLANE1-
44	RXLANE1+
43	GND
42	RXLANE0-
41	RXLANE0+
40	GND
39	RESERVED
38	RESERVED
37	GND
36	GND

1	GND
2	GND
3	GND
4	5.0V (Not in USE)
5	3.3V
6	3.3V
7	APS
8	APS
9	LASI
10	RESET
11	VEND SPECIFIC
12	TX ON/OFF
13	RESERVED
14	MOD_DET
15	VEND SPECIFIC
16	VEND SPECIFIC
17	MDIO
18	MDC
19	PRTAD4
20	PRTAD3
21	PRTAD2
22	PRTAD1
23	PRTAD0
24	VEND SPECIFIC
25	APS SET
26	RESERVED
27	APS SENSE
28	APS
29	APS
30	3.3V
31	3.3V
32	5.0V (Not in USE)
33	GND
34	GND
35	GND

Top of Transceiver PCB

Bottom of Transceiver PCB
(as view through top)

Host PCB X2 PINOUT

1	 GND	GND 	70
2	 GND	GND 	69
3	 GND	RESERVED 	68
4	 5.0V (Not in USE)	RESERVED 	67
5	 3.3V	GND 	66
6	 3.3V	TXLANE3- 	65
7	 APS	TXLANE3+ 	64
8	 APS	GND 	63
9	 LASI	TXLANE2- 	62
10	 RESET	TXLANE2+ 	61
11	 VEND SPECIFIC	GND 	60
12	 TX ON/OFF	TXLANE1- 	59
13	 RESERVED	TXLANE1+ 	58
14	 MOD_DET	GND 	57
15	 VEND SPECIFIC	TXLANE0- 	56
16	 VEND SPECIFIC	TXLANE0+ 	55
17	 MDIO	GND 	54
18	 MDC	GND 	53
19	 PRTAD4	GND 	52
20	 PRTAD3	RXLANE3- 	51
21	 PRTAD2	RXLANE3+ 	50
22	 PRTAD1	GND 	49
23	 PRTAD0	RXLANE2- 	48
24	 VEND SPECIFIC	RXLANE2+ 	47
25	 APS SET	GND 	46
26	 RESERVED	RXLANE1- 	45
27	 APS SENSE	RXLANE1+ 	44
28	 APS	GND 	43
29	 APS	RXLANE0- 	42
30	 3.3V	RXLANE0+ 	41
31	 3.3V	GND 	40
32	 5.0V (Not in USE)	RESERVED 	39
33	 GND	RESERVED 	38
34	 GND	GND 	37
35	 GND	GND 	36

Pin Descriptions

Signal Name	Level	I/O	Pin NO.	Description
GND			1,2,3,33,34,35,36,37,40, 43,46,49,52,53,54,57,60, 63,66,69,70	Ground connection for signal ground on the module
APS	+1.2V		7,8,28,29	Input from Adaptive Power Supply
APS SENSE	+1.2V		27	APS Sense Output. Connected to the APS Sense Output.Connected to the APS input from APS
APS SET			25	Feedback input from APS.Connected to GND through a 1.18Kohm resistor inside the transponder.
3.3V	+3.3 V DC		5,6,30,31	DC Power Input,+5.0 V DC,Nominal
Reserved			25	Reserved for APD
Reserved			13	Reserved
MDIO	Open Drain	I/O	17	Management Data I/O.Requires external 10-22KΩ pull-up to the APS on host
MDC	1.2V CMOS	I	18	Management Data Clock Input
PRTAD4	1.2V CMOS	I	19	Port Address Input bit 4
PRTAD3	1.2V CMOS	I	20	Port Address Input bit 3
PRTAD2	1.2V CMOS	I	21	Port Address Input bit 2
PRTAD1	1.2V CMOS	I	22	Port Address Input bit 1
PRTAD0	1.2V CMOS	I	23	Port Address Input bit 0
LASI	Open Drain	O	9	Link Alarm Status Interrupt Output. Open Drain Compatible Output with 10 - 20 kΩ pull-up on host. Logic high = Normal Operation Logic low = Status Flag Triggered
RESET	Open Drain	I	10	Reset Input. Open Drain Compatible Input with 22 kΩ pull-up to APS internal to transponder. Logic high = Normal Operation Logic low = RESET
Vendor Specific			11,15,16,24	Vendor Specific Pins. Leave unconnected when not used.
TX ON/OFF	Open Drain	I	12	TX ON/OFF Input. Open Drain Compatible Input with 22 kΩ pull-up to APS internal to transponder. Logic high = Transmitter On Logic low = Transmitter Off
MOD DETECT		O	14	Pulled low inside transponder through a 1 kΩ resistor to Ground

Reserved		I	67,68,38,39	Reserved For Future Use
TX LANE 3-		I	65	Module XAUI Input Lane 3-
TX LANE 3+		I	64	Module XAUI Input Lane 3+
TX LANE 2-		I	62	Module XAUI Input Lane 2-
TX LANE 2+		I	61	Module XAUI Input Lane 2+
TX LANE 1-		I	59	Module XAUI Input Lane 1-
TX LANE 1+		I	58	Module XAUI Input Lane 1+
TX LANE 0-		I	56	Module XAUI Input Lane 0-
TX LANE 0+		I	55	Module XAUI Input Lane 0+
RX LANE 0+		O	41	Module XAUI Output Lane 0+
RX LANE 0-		O	42	Module XAUI Output Lane 0-
RX LANE 1+		O	44	Module XAUI Output Lane 1+
RX LANE 1-		O	45	Module XAUI Output Lane 1-
RX LANE 2+		O	47	Module XAUI Output Lane 2+
RX LANE 2-		O	48	Module XAUI Output Lane 2-
RX LANE 3+		O	50	Module XAUI Output Lane 3+
RX LANE 3-		O	51	Module XAUI Output Lane 3-

Block Diagram of Adapter Power Supply Circuit

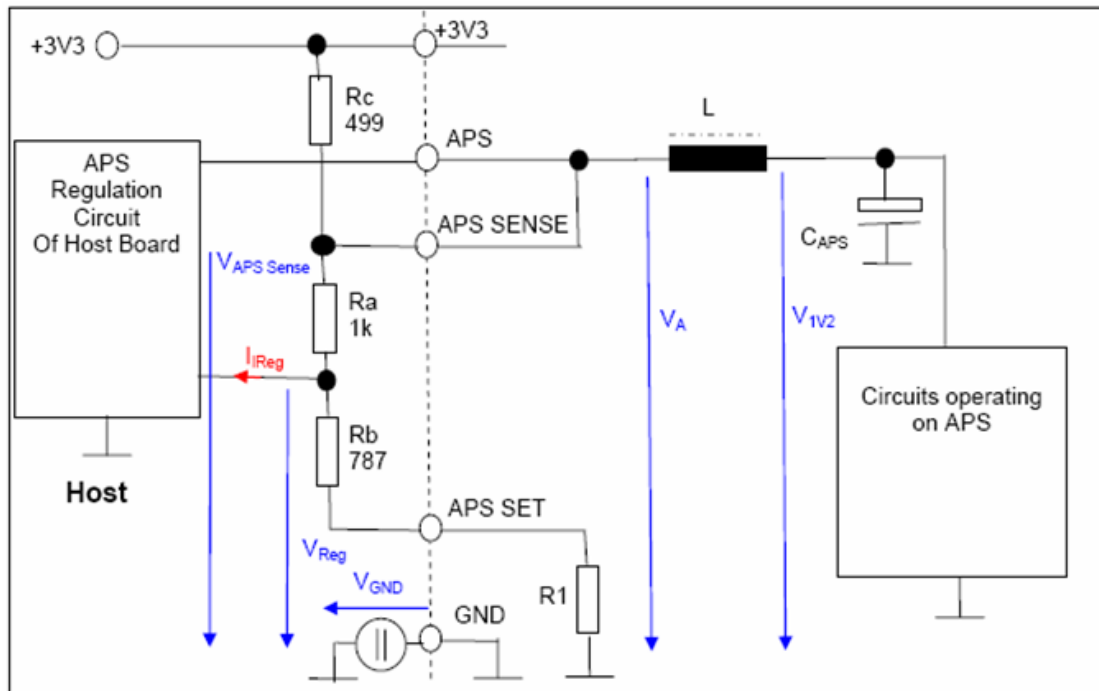

Eye Safety

This laser based multimode transceiver is a Class 1 product. It complies with IEC 60825-1 Ed.2: 2007 and FDA performance standards for laser products (21 CFR 1040.10 and 1040.11) except for

deviations pursuant to Laser Notice 50, dated June 24, 2007.

Package Outline

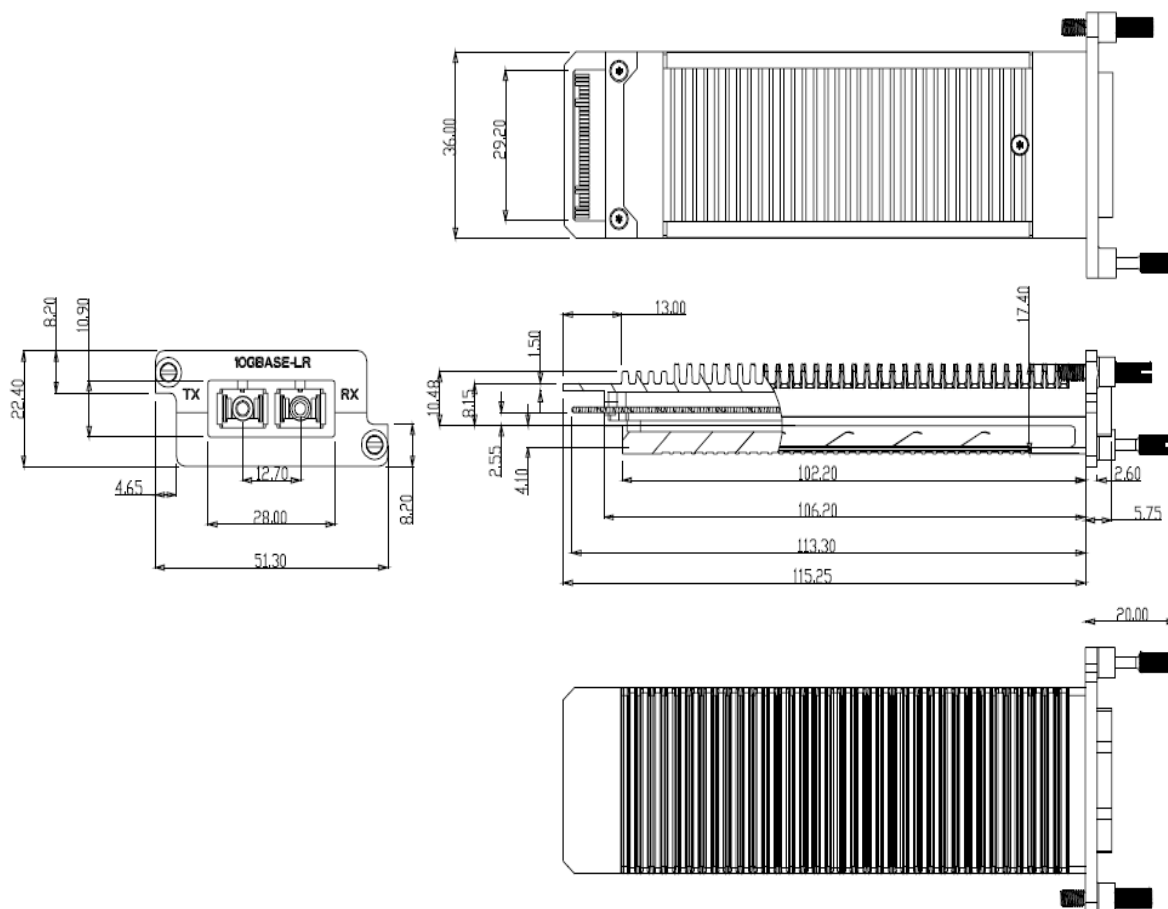

Ordering information

Part Number	Product Description
HXENPAK-10GB-LR	1310nm, 10.3125Gbps, 10Km, 0°C ~ +70°C